



Chemical Injection Technologies

Installation/Service Bulletin

SUPERIOR AutoValve Series 2000 Electronic Gas Feed Rate Control Valve (Ver. 2.02 to 2.12)

Table of Contents

1.0 Description	7.0 Flow Proportioning Control Operation
2.0 Defining The Three Control Modes	7.1 Calibrate
3.0 Electronic Automatic Valve Controller	7.2 Run
3.1 Physical Inputs	7.3 Stop
3.2 Keyboard Inputs	8.0 Residual Control Operation
3.3 Outputs	8.1 Calibrate
3.4 Alarm Relay	8.2 Program
3.5 Power Supply	8.3 Run
4.0 Installation Procedures	8.4 Stop
4.1 Wiring	9.0 Compound Loop Control Operation (2 Inputs)
4.2 Mounting	9.1 Program
4.3 Vacuum Line Piping	9.2 Run
4.4 Start-Up	9.3 Stop
5.0 Procedures Common to all Control Modes	10.0 Appendix
5.1 Passwords (<i>Read Carefully</i>)	11.0 Valve Parts List
5.2 Set Control Mode	
5.3 Calibration	
5.4 Alarm Set Points	
6.0 Manual Control	

1.0 DESCRIPTION

- 1.1 SUPERIOR AutoValve Series 2000 Electronic Gas Feed rate Control Valve is a state-of-the art, micro-processor based device for automatically controlling the feed rate of chlorine/sulphur dioxide/ammonia gas, based on process water flow rate, residual set point, or a combination of these parameters to achieve:
 - Flow Proportioning Control
 - Residual Control (Including De-Chlorination)
 - Compound Loop Control
- 1.2 The Series 2000 is a flexible instrument, ruggedly designed, with a very user-friendly interface.
- 1.3 The valve is designed to operate with virtually any brand of vacuum fed CL_2 , SO_2 or NH_3 gas system.
- 1.4 The electronic components are housed in a rugged plastic enclosure, rated for protection at NEMA 12/13 levels.
- 1.5 The valve components can be remotely mounted up to 100' (30 meters) from the electronics enclosure. [Note: special cable may be required for remote installation]
- 1.6 Separate terminal compartment in the electronics enclosure allows convenient wiring connections without opening or disturbing the electronics boards.
- 1.7 Display is a 2-line, 16 character, back lighted LCD. It allows easily understood visual indication of specific application parameters.

- 1.8 A high-torque stepper motor positions the valve in response to input signal changes from an outside source, such as a flowmeter or residual analyser.
- 1.9 Standard 4 - 20mA output signal is provided for interfacing with other process monitoring equipment.
- 1.10 The LCD display allows visual indication of input signal and valve position.
- 1.11 AutoValve Series 2000 Automatic valve will operate with any Cl_2 , SO_2 or NH_3 vacuum operated gas feed system up to 2000 PPD (40 kg/hr).
- 1.12 Controls provide dosage ratio control, residual set point, manual operation, alarm set points and calibration.

2.0 DEFINING THE THREE CONTROL MODES:

2.1 FLOW PROPORTIONING CONTROL

Flow proportioning control is the simplest control mode. It involves very little in the way of program variable settings, and tends to be the most reliable form of automatic control. It is often referred to as an "OPEN LOOP" control mode, because the action which is being controlled, the gas feed rate which creates a residual level, is not being monitored and fed back into the control system to determine if the correct action has indeed taken place. Instead, the primary control signal is generated by a water flow meter which constantly measures the amount of water flowing through a treatment system. The water flow meter cannot determine if the amount of gas being fed is creating the proper residual level.

Therefore, Flow Proportioning Control is most properly suited to treatment systems where the chlorine or sulfur dioxide "demand" of the water remains fairly constant. As the water flow level varies up or down, the control system varies the feed rate of chlorine or sulfur dioxide gas, in direct proportion to the water flow change. If the "demand" of the treated water changes, the residual will also change. This will require a simple adjustment of the "DOSAGE" variable setting in the controller menu. Adjusting the dosage setting up or down will shift the gas feed rate up or down, respectively, at any specific water flow rate. After the initial calibration setup of the AutoValve, the dosage setting is the only variable in the treatment system that needs to be adjusted.

When "demand" of the water being treated varies on a frequent basis, you may wish to consider RESIDUAL CONTROL, or COMPOUND LOOP CONTROL, which are discussed below. However, you should understand that use of a water flow meter as the primary control signal source, is the most reliable and maintenance-free control signal generating device. Residual analyzers, while more reliable today than just a few years ago, are still much more maintenance intensive, requiring frequent cleaning and calibrating in order to give an accurate output signal to any control device.

2.2 RESIDUAL CONTROL (Chlorination and De-Chlorination)

Residual Control, while somewhat more complicated than Flow Proportioning control, does afford the user a higher degree of precise control over chlorine or sulfur dioxide (in de-chlorination) residual levels in treatment plants. This is most critical when components of the chlorine or sulfur dioxide "demand" will vary, causing the need for a higher or lower dosage rate on a continual basis. A chlorine residual analyzer is required which is capable of **continuous sampling**, rather than **batch sampling**. Amperometric analyzers are the most reliable for control systems, but ORP type analyzers may be used if the output variables of the analyzer, as well as interference factors, are fully understood. Most colorimetric type analyzers are not well suited for continuous control systems. While some colorimetric analyzers may have programming algorithms which allow the output signal to be continually produced, a discussion of the AutoValve programming adjustments necessary to synchronize the variables is beyond the scope of this manual.

Because the Residual Control system does feed back to the controller the result of changes which have been made by adjusting the gas feed rate, it is considered a "CLOSED LOOP" type of control system. However, the very nature of closed loop control systems require more variable inputs in order to achieve residual control without having a "ping pong" residual level through over-shooting the desired set point for residual. The primary reason for this to happen is the fact that the analyzer "sees" the result of changes made in gas feed rates, on a delayed basis. Time must be allowed for the gas to mix with the treated water and to react with the organic constituents of the water before taking the residual sample. Therefore, changes required in gas feed rates must be done in "steps", allowing time for the analyzer and the AutoValve controller to "see" what effect the previous change has had on the residual level of the treated water. But, how big should these "steps" be, and how often should they take place? Also, as the "steps" bring the residual closer to the "set point" level, how do we keep the last step from over-shooting the set point, and just bouncing back and forth around the set point (as in a ping pong game)?

It is important to note that when the AutoValve is used for de-chlorination with Sulfur Dioxide gas, it operates in an inverse manner to a chlorine residual control system. Since the objective in de-chlorination is to drive the chlorine residual to a zero (0) or very low chlorine residual set point by the addition of Sulfur Dioxide Gas, the valve will

increase SO₂ feed when the chlorine residual is higher than the set point, and decrease the SO₂ feed rate when the chlorine residual is lower than the set point. This is exactly the opposite of a chlorine residual control system. The controller allows the user to choose the GAS TYPE from the programming section of both the Residual Control and compound Loop Control modes.

Fortunately, today's digital control systems allow us to take all of these variables into account, and automatically make the necessary adjustments after the initial variable parameters are entered into the controller. Let's take a look at the most important variable inputs you will need to understand:

2.2.1 RES FS [RESIDUAL ANALYZER FULL SCALE OUTPUT]

This is simply the residual reading in parts per million (PPM) or milligrams per liter (mg/L) which is represented by the maximum output of your analyzer. Normally, it is the residual represented by a 20 milliamp analyzer signal output. (*Warning:* if your analyzer has any other type of output signal- millivolts, volts, higher or lower milliamp ranges, etc.- it is likely to be incompatible with the AutoValve, and may cause damage to the controller. It may be possible to use signal conditioners or other means to make the output signal compatible, but Chemical Injection Technologies, Inc. makes no promise or representation that this will be possible).

2.2.2 LAGFIX [LAG TIME SETTING]

Lag time is the amount of time, in seconds, that it takes for the chlorine or sulfur dioxide gas injected into the water, to reach the analyzer, go through the measuring cell, and send the resulting reading back to the AutoValve controller. This value must be calculated based upon the water flow rate in the system, added to the analyzer sampling time. Standard tables are available to determine the speed of travel of water in pipe of various diameters with a known water flow rate in gallons per minute, liters per second, etc.

2.2.3 P(GAIN) -

The "**P(GAIN)**" variable allows an adjustment of the sensitivity of the controller to residual changes. It is necessary to allow the possibility of such an adjustment because of the wide variations in treatment system characteristics, which may cause very large, rapid changes in residual, or very little changes in residual. One system may only experience extremely minor fluctuations in demand, on a relatively infrequent basis, while another has almost constant changes. The default setting of 100% will satisfy the vast majority of installations.

We have found it useful to use the following description to explain this concept, even though it is not technically completely accurate. Think of the **P(GAIN)** as a series of concentric, electronic circles around the residual set point value. As the circles get farther away from the center set point, the distance between the circles becomes progressively larger. When the analyzer senses a residual that deviates from the center set point value, the controller checks to see how far away the actual value is from that set point. The signal value will fall within one of the series of "circles". Each of these circular areas represents an amount of change in the valve position for each time the analyzer senses a deviation from the set point, after recovering from the "**LAGFIX**" time delay. The farther away the signal value is from the set point, the larger the initial change in valve position. Each successive change will be progressively smaller. In this manner, the valve will be able to adjust the residual within a reasonable amount of time, without over-shooting the set point, and bouncing around it.

However, there are limitations to the controllers ability to balance between quickly adjusting the feed rate of gas, but not overshooting the residual set point. For example, if a treatment system experiences frequent, very large changes in demand, and therefore residual, it may take a long time for the controller to step down through many "circles" because the initial deviation is so far away from the set point. This is where the "**P(GAIN)**" variable comes into play. We can adjust the **P(GAIN)** value higher to make the controller more sensitive to the residual signal and therefore making the distance between the "circles" much greater. This has the effect of reducing the number of "circles" through which the controller must step, in order to reach the set point. The trade-off is that there is more likelihood that the residual level will overshoot the set point, at least on the first pass.

On a system where the demand is constantly fluctuating, but only a very small amount, if the **P(GAIN)** were to be set at a high value, as above, the valve would be constantly moving up and down because every little deviation in the analyzer signal will cause the controller to react. Most systems can handle very minor fluctuations in residual without compliance problems, and constant movement of the AutoValve will cause more frequent maintenance and wear. Setting the **P(GAIN)** to a lower value will require a larger deviation in the residual from the set point before any action is taken by the controller. In effect, the distance between the "circles" is reduced, so that the first deviation point is farther away from the set point, but each successive circle is closer to the next. The trade-off in this scenario is that a larger deviation will take a very long time to reach the set point because the controller must step through many "circles".

The **P(GAIN)** is an error damping adjustment, used to determine the sensitivity of the controller to residual changes. It is different from the calibration "Damping" because the **CAL DMP** is only changing the input signal sampling time, while **P(GAIN)** adjusts the actual signal deviation required to make a change.

2.3 COMPOUND LOOP CONTROL

Compound Loop Control allows the controller to accept two input signals at the same time: one from a water flow meter, and one from a residual analyzer. While the most complex control mode, compound loop is most effective when demand varies, but water flow rates also fluctuate significantly. If a Residual Analyzer signal is the only input, a rapid increase in water flow will quickly dilute the gas dosage, far more rapidly than the analyzer can react and allow the controller to adjust the valve through the residual deviation “steps” discussed above. This would cause a large decrease in residuals for a significant amount of time. Conversely, a rapid decrease in water flow would cause a big “spike” in residuals.

Likewise, if a water flow meter is the only signal input, changes in demand will cause the constant gas dosage to either over, or under, treat the water. Compound Loop Control addresses these situations. Since water flow variations create the most immediate need for a rapid valve response, the AutoValve uses its Flow Proportioning mode as the primary control system. The residual input signal takes the place of an operator making continual residual samples and then adjusting the **DOSAGE** variable. It is like an electronic “hand” going to the controller menu and pressing the control buttons to adjust the **DOSAGE** setting.

All of the program variables discussed above for Residual Control, including the discussion regarding De-Chlorination with SO₂ gas, also apply for Compound Loop Control, with the addition of the “**LAG**” type setting. This allows the **LAG TIME** value which was set for a particular water flow rate, to be automatically varied as the water flow rate increases or decreases. By allowing **VARIABLE LAG TIME** the analyzer always “sees” the sample after equal mixing has taken place. For example; if water flow in a pipeline doubles (a second well pump comes on line) the amount of time it takes for the treated water to reach the analyzer is one-half the previous amount, and the **VARIABLE** setting will automatically adjust the **LAG TIME**. However, in many “open” treatment systems, higher water flow rates do not necessarily increase the speed at which water travels through the system (at least not proportionately) and the **FIXED** setting may be chosen.

3.0 ELECTRONIC AUTOMATIC VALVE CONTROLLER

The electronics enclosure module of the Series 2000 is henceforth referred to as the *CONTROLLER*. The controller accepts a signal from a flowmeter, residual analyser, or both, and adjusts a motorized valve. The motorized valve is housed in a separate valve module.

3.1 PHYSICAL INPUTS

- 3.1.1 FLOW: 4-20 mA floating input through a load resistor of 250 Ohm to local ground.
- 3.1.2 RESIDUAL: 4-20 mA floating input through a load resistor of 250 Ohm to local ground.
- 3.1.3 VALVE POSITION: Potentiometer input, approximately 0.25 to 2.25 VDC.

3.2 KEYBOARD INPUTS

- 3.2.1 Dosage Ratio.
Example: fully open = 100% @ 20mA
- 3.2.2 Flow Mode, Residual Mode, Compound Loop Mode.
- 3.2.3 Manual position override.
- 3.2.4 Calibration for VALVE CLOSED.
- 3.2.5 Calibration for VALVE 25% OPEN
- 3.2.6 Calibration for VALVE 50% OPEN
- 3.2.7 Calibration for VALVE 100% OPEN.
- 3.2.8 Alarm Relay for LOW FLOW, RESIDUAL DEVIATION.
- 3.2.9 4 - 20mA IN, 4 - 20mA OUT.
- 3.2.10 LAG TIME adjust for Residual & Compound Loop Modes.
- 3.2.11 CHLORINATION/DE-CHLORINATION (SO₂) control modes.
- 3.2.12 GAIN sensitivity adjustment for SET POINT deviation.

3.3 OUTPUTS

- 3.3.1 2.5 VDC potentiometer excitation
- 3.3.2 4 - 20 mA reference to local ground- 600 Ohm drive (maximum)

3.4 ALARM RELAY

- 3.4.1 Alarm relay contact 10 amps at 120 VAC or 30 VDC resistive load, 5.0 amps at 240 VAC resistive load, unlatching. Adjustable settings for LOW FLOW alarm, and RESIDUAL SET POINT DEVIATION alarm.

3.5 POWER SUPPLY (VOLTAGE)

- 3.5.1 The operating voltage may be selected by a switch mounted on the main circuit board, located under the display panel: 110 or 220 VAC, 50 or 60 Hertz.
- 3.5.2 Power is immediately converted to 24 Volts DC for all valve operations.

4.0 INSTALLATION PROCEDURES (SEE DRAWINGS IN APPENDIX)

(Refer to FIGURE 4.0 for typical valve setup)

WARNING: *Operators must familiarize themselves with all cylinder or ton container handling and changing procedures. Refer to literature supplied with the gas feeding equipment. Additional information may be supplied by the manufacturer of the gas feeding equipment.*

4.1 MOUNTING

- 4.1.1 The Series 2000 is supplied with a wall mounting sub-panel. The separate modules are attached to the panel by means of pre-positioned fasteners. Modules may also be remotely mounted when special considerations require separating the components.
- 4.1.2 The panel may be mounted on any vertical surface using the proper hardware for the type of surface. The Series 2000 is NOT DESIGNED FOR OUTDOOR INSTALLATION. IF CIRCUMSTANCES REQUIRE OUTDOOR INSTALLATION, THE CLEAR COVER MUST BE KEPT CLOSED AND THE UNIT PROTECTED FROM THE ELEMENTS.
- 4.1.3 The electronics enclosure, valve module and remote meter panel are shipped pre-installed on the sub-panel (See figure 4.1). Check all components to insure that they are securely fastened. Any or all components may be mounted separately, but it is suggested that the remote gas feed rate flow meter panel be located where it can be seen while making adjustments to the electronics module. This will make calibration easier.

4.2 WIRING

- 4.2.1 Installing electrical wiring for the Series 2000 AutoValve requires connection of 4-20mA input signal(s), 110 VAC, 60 Hz power supply (or optional 220 VAC, 50 Hz).
- 4.2.2 The AutoValve is shipped with the connecting cable between the electronics module and the valve module, already pre-wired. If the installation requires these two components to be separated, an appropriate length and type of cable must be provided and the wiring connections must be undone and rewired according to the WIRING CONNECTIONS diagrams as shown in FIGURE 4.2. *NOTE: Incorrect wiring, or use of inadequate cable, resulting in AutoValve malfunction or damage will void all warranties.*
- 4.2.3 The AutoValve is shipped with watertight strain reliefs installed. However, these may be removed and any standard ½" conduit fittings substituted. 18 to 22 gauge two conductor shielded cable is recommended for the input signal(s) and 18 to 20 gauge grounded two conductor wire for the power supply.
- 4.2.4 Connect the power supply leads to the terminals as shown on the WIRING CONNECTIONS diagram (Figure 4.2). **The Series 2000 AutoValve must be properly grounded.**

NOTE: It is strongly suggested that the power supply be protected from voltage spikes and drops, and especially from lightning strikes. We highly recommend installation of an uninterruptible power supply (UPS) of the type used to protect computers. These are readily available at electronics stores, office supply stores and home improvement stores, at relatively low cost. DAMAGE DUE TO VOLTAGE SPIKES OR LIGHTNING IS NOT COVERED BY WARRANTY.

- 4.2.5 Connect the 4 - 20mA control signal(s) to the correct terminals. Also connect any necessary output signal wiring, and wiring to alarm signaling device(s).

NOTE: Before wiring the input control device signal(s) to the terminal board, you must refer to the operator's manual pertaining to the input signal device(s). **Be especially certain that the Flow Meter or Residual Analyzer being used does NOT generate a VOLTAGE BASED signal (ex: 0 to 5 Volts DC), or you will cause irreparable damage to the controller.** The AutoValve requires a 4 - 20 mA signal in order to operate in Automatic Mode. If no signal is present, the display characters "-XX.XX%" will appear on the screen when calibrating input signals or when operating in "RUN" function, indicating an open signal.

4.3 VACUUM LINE PIPING

- 4.3.1 The Series 2000 AutoValve is designed to be installed in the vacuum gas line between the ejector and the remote metering panel or vacuum regulator (if equipped with integral flowmeter). All manual flow rate valves must be in the FULL OPEN position. See Figure 4.1.
- 4.3.2 Attach the vacuum tubing from the ejector to the bottom fitting of the valve module, labeled "Vacuum to Ejector". Attach the vacuum tubing from the remote meter panel (or regulator) to the fitting on the side of the valve module. Tighten all fitting nuts by hand only - **DO NOT USE WRENCHES (SPANNERS) OR PLIERS.**

4.4 START-UP

4.4.1 TESTING FOR VACUUM LEAKS

- 4.4.1.1 With the ejector operating, and the gas cylinder valve still closed, the ball in the metering tube will remain at the bottom. If the ball does not remain at the bottom, or bounces up and down, there is either a leak at the lead gasket where the vacuum regulator connects on the cylinder valve or a loose vacuum connection in the system. Check and correct.
- 4.4.1.2 The gas supply indicator on the face of the regulator should indicate an "out of gas" condition. Double check by attempting to RESET the indicator. It should NOT be able to be reset.
- 4.4.1.3 Close the ejector water supply valve or turn off the booster pump to stop operation of the ejector.

4.4.2 TESTING FOR GAS LEAKS

- 4.4.2.1 Open the gas cylinder valve 1/4 turn and *close immediately*. The system should be full of gas just below atmospheric pressure.
- 4.4.2.2 Using the recommended testing method for the gas being fed (see below), check all fittings and connections as well as the body seams and seal areas of the AutoValve.

4.4.3 RECOMMENDED GAS TESTING METHODS.

- 4.4.3.1 CHLORINE & SULFUR DIOXIDE: Fill a small plastic squeeze bottle about 1/4 full with a strong ammonium hydroxide solution and squeeze the vapor from this bottle at each fitting and seam. DO NOT POUR AMMONIA SOLUTION ON THE EQUIPMENT. In lieu of the squeeze bottle, a small piece of cloth can be wetted with the Ammonia solution and held under each connection. If chlorine or sulfur dioxide is leaking, a white smoke will appear similar to cigarette smoke.
- 4.4.3.2 AMMONIA: Fill a small plastic squeeze bottle about 1/4 full with a strong chlorine bleach solution and squeeze the vapor from this bottle at each fitting and seam. DO NOT POUR BLEACH SOLUTION ON THE EQUIPMENT. In lieu of the squeeze bottle, a small piece of cloth can be wetted with the Bleach solution and held under each connection. If chlorine or sulfur dioxide is leaking, a white smoke will appear similar to cigarette smoke.

NOTE: THERE ARE FACTORY DEFAULT SETTINGS BUILT INTO THE AUTOVALVE. IF AT ANY TIME YOU ENCOUNTER A CALIBRATION OR SETTING DIFFICULTY WHICH RESULTS IN A "LOCKUP" SITUATION, TURN OFF THE AC POWER TO THE CONTROLLER, WAIT 15 SECONDS TO POWER DOWN THE CAPACITORS, THEN HOLD DOWN THE F4 BUTTON WHILE TURNING ON THE POWER AGAIN. WAIT UNTIL THE SCREEN SAYS "FACTORY DEFAULT", RELEASE THE F4 BUTTON, AND WAIT UNTIL THE MAIN MENU COMES UP. RECALIBRATE FOLLOWING INSTRUCTIONS IN SECTION 5.0. IF MAIN POWER TO THE CONTROLLER IS TURNED OFF FOR SHORT PERIODS (UP TO 3 DAYS), THE SYSTEM SHOULD RETURN TO THE PREVIOUS FUNCTION POINT, AND NO RE-CALIBRATION IS REQUIRED.

4.4.4 POWER UP THE CONTROLLER

- 4.4.4.1 When all of the above installation & startup procedures have been completed, apply main power to the controller.
- 4.4.4.2 A series of opening screens will appear, giving information about the firmware version, etc.
- 4.4.4.3 After a few seconds the main controls screen [1F, 1R or 1C] will appear if this is the first time you have powered up the controller and have not previously turned off the power in the "RUN" condition. The main controls screen will show the control mode (FLOW, RESIDUAL or COMPOUND LOOP) which was last set:

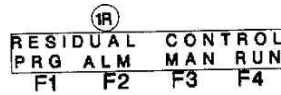
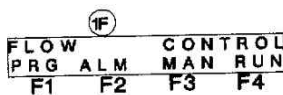

If this first time you are turning on the power to the AutoValve, the opening screen will default to the last screen which was open before power was turned off.

- 4.4.4.4 Proceed to SECTION 4.1 for instructions regarding use of the PASSWORD SYSTEM, and then set the control mode you wish to use: see SECTION 4.2.

5.0 PROCEDURES COMMON TO ALL CONTROL MODES

(See the Menu System Flow Diagram for a complete overview, and to help in navigating through the various levels of the AutoValve user interface. All menus shown in this manual are numbered to correspond with menus on the Menu System Flow Diagram).

5.1 PASSWORDS (READ CAREFULLY)

5.1.1 The SUPERIOR AutoValve has a two (2) level password protection system built into the user interface menu structure. One password can be set for programming operations, and another (or the same password) can be set to allow changes in alarm set points, or residual or flow dosage set points. This allows supervisory and/or management personnel to choose whether or not to allow access to some or all operations personnel. It is designed to prevent unauthorized persons from changing the programming settings (calibration & residual settings), the alarm settings, and the dosage & residual setpoints. Either of these passwords may be independently set, or may be the same.

5.1.2 **IMPORTANT!!!** Once a password has been set, it cannot be changed unless the old password is used first. It is strongly suggested that a master copy of all passwords be kept in a secure place. If any password is forgotten, you will be effectively locked out of that section of the menu system. If passwords are not available and changes must be made, the controller will have to be returned to the factory to be “unlocked”.

5.1.3 FACTORY DEFAULT PASSWORDS

5.1.3.1 Default AutoValve passwords, as supplied from the factory, are all set at “0000”. **IMPORTANT!!!** It is strongly recommended that new passwords (different from the factory default “0000”) be entered as soon as possible, to prevent unauthorized setting of a password which will lock out supervisory personnel.

5.1.4 PASSWORD ENTRY SCREENS

5.1.4.1 All password entry screens are identical in appearance: see “PASSWORD” Menu [2]. When you first encounter the password entry menu, it will appear with the number “0” as the first digit, and an asterisk (*) in place of the last three digits. You must enter each digit by using the F1 & F2 keys to scroll up & down from 0 to 9. When the proper number appears, press the NXT key (F4). The next number can now be entered in the same manner, pressing the NXT (F4) key when correct. After all four numbers are entered the screen will automatically open the next menu.

②

P	A	S	S	W	O	0	*	*	*			
U	P	↓	D	W	N	↑	E	S	C	N	X	T
F1	F2	F3	F4									

5.1.5 PASSWORD SET/CHANGE SCREENS

5.1.5.1 The two password change screens “SET PW” [25A], are used in an identical manner to the “PASSWORD” Menu (2), above. The asterisk is replaced by a question mark(?). These password change menus are always shown as an option, “SET NEW PASSWORD” [26], when exiting from the PROGRAMMING function, or from the ALARM SET function. Pressing the ESC key (F3) aborts the new password setting and exits to the main menu [1]

②B

S	E	T	N	E	W	P	A	S	S	W	O	R
Y	E	S	N	O								
F1	F2	F3	F4									

②6A

S	E	T	P	W	0	?	?	?				
U	P	↓	D	W	N	↑	E	S	C	N	X	T
F1	F2	F3	F4									

5.1.5.2 After the last digit is entered, pressing the NXT key (F4) then shows the “NEW PASSWORD STORED” menu [26B, or 33], and then automatically exits to the Main Menu [1]

②6B

N	E	W	P	A	S	S	W	O	R	
S	T	O	R	E	D					
F1	F2	F3	F4							

5.1.6 FUNCTIONS PROTECTED BY PASSWORDS

5.1.6.1 PROGRAM Password
 CALIBRATION
 PROGRAM PARAMETERS
 SET MODE

5.1.6.2 ALARM Password

ALARM SET POINT
 DOSAGE SET POINT
 RESIDUAL SET POINT

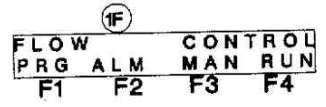

5.2 SET CONTROL MODE

When you view the opening menu [1F, 1R, or 1C], if the control mode shown is not the one you desire to use, proceed as below. If the control mode is correct, skip to 5.3 CALIBRATION.

5.2.1 From the opening Menu [1F, 1R, or 1C], press PRG key (F1).

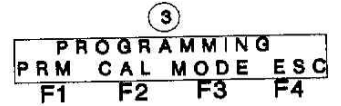

5.2.2 The "PROGRAMMING" menu [3] opens. Press the MODE key (F3).

5.2.3 The "CONTROL MODE" menu [4F, 4R, or 4C] opens. Press the UP (F1) or DWN (F2) key to cycle through the three control modes and choose FLOW, for Flow Proportioning, RES for Residual Control, or COMP for Compound Loop Control. When the desired control mode is shown, press SET (F4).

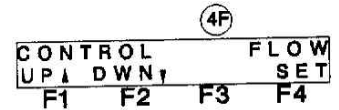

5.2.3 This exits back to the "PROGRAMMING" Menu [3]

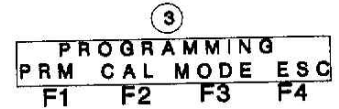

5.3 CALIBRATION

There are two types of calibration which can be done:

1. INPUT/OUTPUT (I/O)Signals
2. VALVE Linearity and Span

The AutoValve Series 2000 INPUT/OUTPUT (I/O) signal calibration has been done at the factory and generally is not necessary to be done in the field, unless the milliamp signal generated by the water flowmeter or residual analyzer does not read 4.0 mA at 0% Flow or Residual PPM, and 20.0 mA at maximum Flow or Residual. If your Input devices do not read true, then follow INPUT/OUTPUT CALIBRATION instructions in Section 5.3.2

VALVE LINEARITY & SPAN Calibration should always be performed at initial start-up, whenever the motorized valve is disassembled, and after any occurrence which requires powering off and restarting the AutoValve in FACTORY DEFAULT mode (Hold F4 key while turning on power until "FACTORY DEFAULT" shows on screen, release F4 key).

From the "PROGRAMMING" menu [3] press the CAL key (F2). This opens the "CALIBRATE" menu [5].



5.3.1 VALVE LINEARITY & SPAN CALIBRATION

(NOTE: Valve calibration involves matching 4 separate gas feed rates with their representative water flow meter mA input signals. This automatically allows the valve to determine the linear range between the maximum gas flow desired at the maximum range of the water flow meter, and the "zero flow" point of the gas feed and water flow meter. IT IS VERY IMPORTANT that the AutoValve is sized within a range that is consistent with the maximum expected water flow and gas dosage. If you are unsure of this, contact your dealer or Chemical Injection Technologies, Inc.)

IMPORTANT: AT THIS POINT IT IS NECESSARY TO HAVE THE GAS FEED SYSTEM IN OPERATION. BE CERTAIN THAT THE EJECTOR IS PRODUCING SUFFICIENT VACUUM AND THE VACUUM REGULATOR IS CONNECTED TO AN OPEN GAS SUPPLY VALVE. VALVE CALIBRATION SHOULD ONLY BE DONE WITH THE DOSAGE LEVEL SET AT 100%.

5.3.1.1 From the "CALIBRATE" Menu [5], press VLV key (F1), which opens the "SELECT POINT" Menu[6].

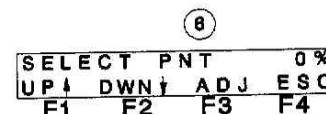

5.3.1.2 Press the UP or DWN keys to change the percentage point which you wish to calibrate. Start by calibrating the “0%” point. Press the ADJ key (F3).

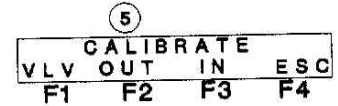

5.3.1.2.1 The “ADJUST PNT 0%” Menu [7] opens.

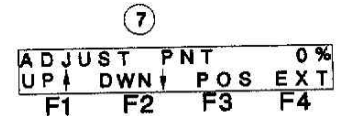

5.3.1.2.2 Pressing the UP, DWN or POS keys at this point will take you to a sub-menu [7A]. The purpose of the “ADJUST PNT 0%” Menu [7] is to allow you to manually adjust the valve position so that the gas flow rate corresponds to the correct feed rate when the input mA signal is at 0%. Note that holding the UP or DWN keys will cause the valve position and gas feed rate to change at a normal rate. Once you have positioned the feed rate you can press the UP or DWN keys repeatedly to get a very precise position. Pressing the POS key (POS is short for POSITION) will QUICKLY MOVE the valve to the “test” position, which will normally be at or near the 0% setting. You can then make the “fine” adjustments using the UP or DWN keys. HOWEVER, once you press the UP or DWN keys from the “ADJUST PNT 0%” Menu [7], you will no longer have the choice of using the quick POS key, since this will immediately take you into the “ADJUST PNT 0%” sub-menu [7A].

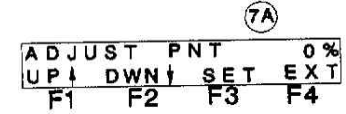

5.3.1.2.3 When the gas feed rate indicated on the gas flow meter is at the correct 0% feed rate, press the SET key (F3), which will take you back to the “SELECT PNT” Menu [6].

5.3.1.3 From the “SELECT PNT” menu [6], repeat the calibration procedure illustrated above (5.3.1.2) for the 25%, 50%, and 100% feed rate positions. Note that **100% does not mean 100% of the gas feed rate shown on the metering tube**. It refers to the gas feed rate you expect to feed when the water flow meter input is at 100%. Likewise for 25% & 50%. The procedure for all four settings is exactly the same. **YOU MUST SET THE 0% AND 100% POSITIONS**. Failure to do this will result in an error message “CALIBRATION ERR: NO SPAN EST” and the system will then go to “RESTORING LAST CALIBRATION”. It is highly recommended that you always set all four positions whenever calibrating.

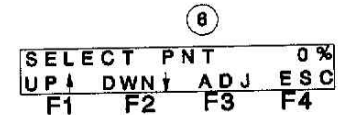

5.3.1.4 After calibrating all four valve positions (after you press the SET (F3) key for the last set point) you will be back at the “SELECT PNT” Menu [20]. Press the RTN key (F4). The “CALIBRATION VALID” screen will show briefly and then the system will go to the “SAVE CALIBRATION” menu [11].

5.3.1.5 From the “SAVE CALIBRATION” Menu [11], press the YES key (F1) to accept the calibration procedure. If you decide that you would like to retain the previous calibration press the NO key (F4).



5.3.1.5.1 Pressing the YES key (F1) will show the “CLOSING VALVE WAIT” Screen, the valve will run down to the 0% position, and then the system will go to the “CALIBRATE” Menu [5].

5.3.1.5.2 Pressing the NO key (F4) will show the “RESTORING LAST CALIBRATION” Screen, and the system will go to the “CALIBRATE” Menu [5]



NOTE: WHEN YOU ARE IN THE “ADJUST PNT” MENUS, YOU MUST ADJUST THE VALVE POSITION BEFORE PRESSING THE **SET** KEY (F3). DO NOT ATTEMPT TO EXIT THE “ADJUST PNT” MENU USING THE “SET” KEY (F3) WITHOUT ADJUSTING THE ACTUAL GAS FLOW RATE OR YOU WILL GET THE FOLLOWING ERROR MESSAGE: “**CALIBRATION ERR: - SLOPE PNT**” WHEN YOU PRESS THE “RET” KEY (F4) ON THE “SELECT POINT” MENU [6]. THE SYSTEM WILL THEN DEFAULT TO THE LAST CALIBRATION.

5.3.1.6 You may choose to exit out to the main control menu [1] by pressing the ESC key (F4) on the “CALIBRATE” menu [5] and the “PROGRAMMING” menu [3], or you may continue in the calibration section

5.3.2 **CALIBRATE INPUT SIGNAL** - The calibration of Input and Output signals is performed at the factory and is not usually necessary. Calibration of Input and Output signals will require use of accurate electronic test instruments. Calibration of Input & Output signals should only be performed by experienced electronics technicians. The following technical information is for general information only. It implies no warranty of any kind. **WARNING: DO NOT APPLY ANY VOLTAGE PRODUCING ELECTRONICS TO THE INPUT TERMINALS. THEY ARE DESIGNED TO RECEIVE A 4-20 mA SIGNAL ONLY**

5.3.2.1 From the opening main menu [1] press the PRG key (F1).

5.3.2.2 The “PASSWORD” menu [2] opens. Enter password: See Section 5.1. After last password digit is entered, press the NXT key (F4), which will open the “PROGRAMMING” menu [3].

5.3.2.3 From the “PROGRAMMING” menu [3] press the CAL key (F3).

5.3.2.4 The “CALIBRATE” Menu [5] opens. Press the IN key [F3]. At this point you must have a mA current SOURCE (signal) across the “FLOW 4-20mA” input terminals. A calibration signal generator is recommended.

NOTE: THE CALIBRATION PROCEDURE ALLOWS YOU TO CALIBRATE BOTH FLOW SIGNAL INPUT AND RESIDUAL ANALYZER SIGNAL INPUT, REGARDLESS OF THE CONTROL MODE CHOSEN. IF YOU ONLY HAVE A FLOW SIGNAL CONNECTED, DO NOT CALIBRATE FOR RESIDUAL SIGNAL, AND VICE VERSA. YOU MUST CALIBRATE BOTH FOR COMPOUND LOOP CONTROL MODE.

5.3.2.5 The “CAL INPUT SELECT” Menu [12] opens. To calibrate the **Flow Meter Input** signal press the FLOW key (F1).

5.3.2.5.1 The “SET FLOW” Menu [13] opens. The XX.XX mA reading will show the mA input signal from your test device source. Set the source signal at 4 mA. Then press the 4mA key (F1) to store the signal into memory. Next, set the source signal at 20mA. Then press the 20mA key to store the signal into memory.

5.3.2.5.2 When you have set both the 4mA and 20mA you may press the RET key (F4) to go back to the “CAL INPUT SELECT” Menu [12] or you may choose to adjust the input signal sensitivity “Damper”, by pressing the DMP key (F3).

5.3.2.5.2.1 If you pressed the DMP key (F3) the “FLOW DAMPING” Menu [14] opens.

5.3.2.5.2.2 The flow damper is actually a method by which you can adjust the sensitivity of the valve electronics to changes in the input mA flow signal. Under normal operating conditions, there would be no need to make any adjustments to the factory

13

SET FLOW	XX.XX mA		
4 mA	20 mA	DMP	RET
F1	F2	F3	F4

12

CAL INPUT SELECT			
FLOW	RES		ESC
F1	F2	F3	F4

1F

FLOW		CONTROL	
PRG	ALM	MAN	RUN
F1	F2	F3	F4

2

PASSWORD	0	*	*	*
UP↓	DWN↑	ESC	NXT	
F1	F2	F3	F4	

3

PROGRAMMING			
PRM	CAL	MODE	ESC
F1	F2	F3	F4

5

CALIBRATE			
VLV	OUT	IN	ESC
F1	F2	F3	F4

12

CAL INPUT SELECT			
FLOW	RES		ESC
F1	F2	F3	F4

13

SET FLOW	XX.XX mA		
4 mA	20 mA	DMP	RET
F1	F2	F3	F4

12

CAL INPUT SELECT			
FLOW	RES		ESC
F1	F2	F3	F4

14

FLOW DAMPING	108		
UP↓	DWN↑		SET
F1	F2	F3	F4

setting. The higher the number shown, the less sensitive the valve will be to very small changes in the input flow signal. The lower the number shown, the more sensitive the valve will be to small changes in the input flow signal. Before changing this number, it is strongly suggested that you contact Chemical Injection Technologies, Inc. Pressing the SET key (F4) will return you to the "SET FLOW" Menu [13], and from there press the RET key [F4] to go back to the "CAL INPUT SELECT Menu [12].

5.3.2.6 To calibrate the **Residual Analyzer Input** signal press the RES key (F2) on the "CAL INPUT SELECT" menu [12].

5.3.2.6.1 Follow the instructions, above, for calibrating the Flow Meter Input signal. They are identical, except for the "SET RES" menu [15] name.

5.3.3 **CALIBRATE OUTPUT SIGNAL** - The calibration of Input and Output signals is performed at the factory and is not usually necessary. Calibration of Input and Output signals will require use of accurate electronic test instruments. Calibration of Input & Output signals should only be performed by experienced electronics technicians. The following technical information is for general information only. It implies no warranty of any kind. *WARNING: DO NOT APPLY ANY VOLTAGE PRODUCING ELECTRONICS TO THE OUTPUT TERMINALS. THEY ARE DESIGNED TO SEND A 4-20 mA SIGNAL ONLY.*

5.3.3.1 From the opening main menu [1] press the PRG key (F1).

5.3.3.2 The "PASSWORD" menu [2] opens. Enter password: See Section 5.1. After last password digit is entered, press the NXT key (F4), which will open the "PROGRAMMING" menu [3].

5.3.3.3 From the "PROGRAMMING" menu [3] press the CAL key (F3).

5.3.3.4 The "CALIBRATE" Menu [5] opens. Press the OUT key (F2). At this point you must have a mA current meter connected across the "OUT 4-20mA" output terminals.

5.3.3.5 The "CAL I OUT POINT" Menu [17] opens. Press the 4mA key (F1).

5.3.3.5.1 The "SET 4mA" Menu [18] opens. Press the UP (F1) or DOWN (F2) keys until the meter reads 4mA. Press SET key (F4).

5.3.3.5.2 The "CAL I OUT POINT" Menu [17] opens. Press the 20mA key (F2).

5.3.3.5.3 The "SET 20mA" Menu [19] opens. Press the UP (F1) or DOWN (F2) keys until the meter reads 20mA. Press SET key (F4).

5.3.3.5.4 The "CAL I OUT POINT" Menu [17] opens. Press ESC key (F4) to return to the "CALIBRATE" Menu [5]. Pressing ESC Key (F4) again will return you to the "PROGRAMMING" Menu [3]. From here, you may press the ESC (F4) and exit through the "SET NEW PASSWORD" menu [26], back to the main

(26)

SET NEW PASSWORD	YES	NO
F1	F2	F3
F4		

(15)

SET RES	XX.XX mA
4 mA	20 mA
F1	F2
F3	F4

(1F)

FLOW	CONTROL
PRG	ALM
F1	F2
F3	F4

(2)

PASSWORD	0	*	*	*
UP↑	DWN↓	ESC	NXT	
F1	F2	F3	F4	

(3)

PROGRAMMING			
PRM	CAL	MODE	ESC
F1	F2	F3	F4

(5)

CALIBRATE			
VLV	OUT	IN	ESC
F1	F2	F3	F4

(17)

CAL I OUT POINT		
4 mA	20 mA	ESC
F1	F2	F3
F4		

(18)

SET 4 mA		
UP↑	DWN↓	SET
F1	F2	F3
F4		

(17)

CAL I OUT POINT		
4 mA	20 mA	ESC
F1	F2	F3
F4		

(19)

SET 20 mA		
UP↑	DWN↓	SET
F1	F2	F3
F4		

(17)

CAL I OUT POINT		
4 mA	20 mA	ESC
F1	F2	F3
F4		

(5)

CALIBRATE			
VLV	OUT	IN	ESC
F1	F2	F3	F4

control menu [1].

5.4 ALARM SET POINTS

The AutoValve Series 2000 is designed to allow you to set independent alarm conditions for Low Flow Signal and Residual Deviation, depending on the control mode you choose. When an alarm condition, or “event”, occurs, a relay is energized which either opens or closes a set of contacts on the Terminal Board. You may choose whether you wish these contacts to be Normally Open (N/O) or Normally Closed (N/C) when the relay is *NOT* energized by an alarm “event”. These contacts can be used as a switch to turn on an external device, which may be up to 240 VAC. See the WIRING DIAGRAM for an example.

5.4.1 From the Opening Main Menu [1] press the ALM key (F2).

5.4.2 The “PASSWORD” menu [27] opens. Enter the password: See Section 5.1. After the last password digit is entered, press the NXT key (F4).

5.4.3 The “ALARM MODE” menu [28] opens. Here you can choose one of two alarm set points, depending on the control mode in which you are working, and whether you wish the alarm contacts to be Normally Open (NO) or Normally Closed (NC):

5.4.3.1 **FLOW (F1)** will open the “MIN FLOW” Menu [29], in the Flow Control and Compound Loop Control Modes. You can set the percentage (%) of maximum water flow input signal at which you wish the alarm relay to be activated, by pressing the UP (F1) or DOWN (F2) keys. When the minimum flow percentage is correct, press the SET key (F4). This will take you back to the “ALARM MODE” menu [28].

5.4.3.2 **DEV (F2)** will open the residual deviation “RES DEV” Menu [30], in the Residual Control and Compound Loop Control modes. You can set the amount of deviation from the residual set point, in Parts per Million (PPM or mg/L), at which you wish the alarm relay to be activated, by pressing the UP (F1) or DOWN (F2) keys. When the Residual Deviation amount is correct, press the SET key (F4). This will take you back to the “ALARM MODE” menu [28].

5.4.3.3 **RLY (F3)** will open the “RELAY POLARITY” menu [39], in all control modes. When an alarm condition, or “event”, occurs, a relay is energized which either opens or closes a set of contacts on the Terminal Board. You may choose whether you wish these contacts to be Normally Open (N/O) or Normally Closed (N/C) when the relay is *NOT* energized by an alarm “event”. Press the UP (F1) or DOWN (F2) keys to change the contact status to NO or NC (NOTE: Factory default is NO). When the RELAY status is correct, press the SET key (F4). This will take you back to the “ALARM MODE” menu [28].

5.4.4 To exit the Alarm section, press the ESC key (F4) on the “ALARM MODE” menu [28].

5.4.5 The “SET NEW PASSWORD” menu [31] opens. If you do not wish to change the password for the ALARM section and the RUN section of the program, press the NO key (F4). This will exit back to the Opening Main Menu [1].

5.4.5.1 If you wish to set a new password, press the YES key (F3). This will open the “SET PW” menu [32]. To set a new password, use the UP (F1) or DWN (F2) keys to change the digits. When the digit is correct, press the NXT key (F4) to move to the next digit. When all four digits are correct, pressing the (F4) key will show the “NEW PASSWORD STORED” screen [33]. And exit back to the Opening Main Menu [1].

5.4.6 ALARM INDICATION

(1F)

FLOW	CONTROL
PRG ALM	MAN RUN
F1 F2	F3 F4

(27)

PASSWORD 0 * * *
UP↓ DWN↑ ESC NXT
F1 F2 F3 F4

(28F)

ALARM MODE
FLOW RLY ESC
F1 F2 F3 F4

(29)

MIN FLOW 0.0%
UP↓ DWN↑ SET
F1 F2 F3 F4

(28C)

ALARM MODE
FLOW DEV ESC
F1 F2 F3 F4

(30)

RES DEV X.XXPP
UP↓ DWN↑ SET
F1 F2 F3 F4

(28C)

ALARM MODE
FLOW DEV ESC
F1 F2 F3 F4

(39)

RELAY POS: N/O
UP↓ DWN↑ SET
F1 F2 F3 F4

(28C)

ALARM MODE
FLOW DEV ESC
F1 F2 F3 F4

(31)

SET NEW PASSWORD
YES NO
F1 F2 F3 F4

(32)

SET PW 0 ? ? ?
UP↓ DWN↑ ESC NXT
F1 F2 F3 F4

(33)

NEW PASSWORD
STORED
F1 F2 F3 F4

5.4.6.1 When an alarm “event” occurs (low flow or residual deviation) and the alarm relay is activated, the screen display will show the parameter that is causing the alarm by “FLASHING” the value on the automatic run mode screen [38F, 38R or 38C].

6.0 MANUAL CONTROL

- 6.1 The SUPERIOR AutoValve Series 2000 can also be operated in a strictly MANUAL mode. When using the manual control mode, all input signals are ignored.
- 6.2 You may enter the manual control mode from any of the three (3) automatic control main opening menus [1F, 1R, or 1C]. Press the MAN key (F3).
- 6.3 The “VALVE” menu [34] opens. You may adjust the valve position, and gas feed rate, to any point you require, by pressing the UP (F1) or DWN (F2) keys. The valve position setting will move very slowly at first, then it will move much more quickly to allow you to rapidly move close to the desired value. Then, you may press the keys repeatedly to make a final, fine adjustment, either up or down.
- 6.4 Pressing the SET key (F4) will exit the “VALVE” menu [34] and take you back to the Main Opening Menu [1F, 1R, or 1C]. The valve will continue to feed gas at the rate which was set in the MANUAL mode, until the RUN key (F4) is pressed to return to automatic control.

①F

FLOW	CONTROL
PRG ALM	MAN RUN
F1 F2	F3 F4

③4

VALVE	XXX.X%
UP↓ DWN↑	SET
F1 F2	F3 F4

①F

FLOW	CONTROL
PRG ALM	MAN RUN
F1 F2	F3 F4

7.0 FLOW PROPORTIONING CONTROL

Follow procedures in this section after you have set the Control Mode to FLOW. See Section 5.2 SET CONTROL MODE, if your Opening Main Menu [1F] does not indicate FLOW CONTROL [1F]. It is important that you read instructions related to PASSWORDS, CALIBRATION, and ALARM SET POINTS, see Section 5.0, PROCEDURES COMMON TO ALL CONTROL MODES, before proceeding.

FLOW		CONTROL	
PRG	ALM	MAN	RUN
F1	F2	F3	F4

7.1 CALIBRATE

7.1.1 If you have not previously calibrated the VALVE function, go to Section 5.3.1. It is not usually necessary to calibrate the input signal, but VALVE LINEARITY & SPAN Calibration should always be performed at initial start-up, whenever the motorized valve is disassembled, and after any occurrence which requires powering off and restarting the AutoValve in FACTORY DEFAULT mode (Hold F4 key while turning on power until "FACTORY DEFAULT" shows on screen, release F4 key).

7.2 RUN

7.2.1 From the "FLOW CONTROL menu [1F], press the RUN key (F4).

7.2.2 The "DOSAGE" menu [35F] opens. This menu allows you to choose whether to change the current dosage setting, or go directly to the automatic Flow Proportioning Control operation "FLOW" Menu [38F], described below.

DOSAGE		100 %	
ADJ	ESC		NEXT
F1	F2	F3	F4

7.2.2.1 To change the current dosage setting, press the ADJ key (F1).

7.2.2.1.1 The "PASSWORD" menu [36F] opens. Enter the password (Section 5.1.3 PASSWORD ENTRY SCREENS, for instructions).

PASSWORD		0	*	*	*
UP↑	DWN↓	ESC	ENT		
F1	F2	F3	F4		

7.2.2.1.2 After entering the last password digit, and pressing the F4 key the "DOSAGE" menu [37F] opens.

DOSAGE		100 %	
UP↑	DWN↓	SET	
F1	F2	F3	F4

7.2.2.1.3 Use the UP (F1) or DWN (F2) keys to adjust the dosage setting. The setting can be any number between 50% and 200%, which is a 4 to 1 range. See SECTION 2.1, FLOW PROPORTIONING CONTROL for a discussion of "Dosage". The factory default setting is 100%, which is also considered to be a 1:1 ratio. This is the setting at which initial calibration of the valve should be made. If residual levels are either too high or too low, the dosage can be lowered or raised, respectively. The controller will automatically adjust the gas feed range to the dosage change. Keep in mind that if the water flow will ever reach 100 % of the flow meters capacity, and that 20 mA input signal has been calibrated to be the maximum gas feed rate available for your valve, then increasing the dosage % above 100% will not allow the valve to properly adjust the gas feeding range. This is because the valve will "top out" at the maximum feed rate of that particular valve plug before the feed rate required by the flow meter input signal is reached.

7.2.2.1.4 When the DOSAGE setting is correct, press the SET key (F4). This will open the FLOW menu [38F].

FLOW		XX.X%	
VALV	XX.X%		STOP
F1	F2	F3	F4

7.2.3 At the FLOW menu [38F] the valve will be in automatic operation.

7.2.3.1 The Input signal from the water flow meter will be shown next to FLOW as a percentage of the maximum flow rate measured by the flow meter.

7.2.3.2 The valve position will be shown next to VALV as a percentage of the maximum calibrated valve opening.

7.2.3.3 It is important that you understand the relationship of the FLOW and VALV values shown on this menu [38F]. At a DOSAGE setting of 100%, the two percentages shown will always be equal after the valve adjusts to a change in water flow. When the water flow changes, the FLOW value will immediately increase or decrease, then the VALV value will start to increase or decrease until it matches the FLOW value. HOWEVER, when the dosage setting is changed to some value other than 100%, then the VALV value will NOT MATCH the FLOW value, but will be offset by the dosage setting. For example: At a Dosage setting of 100%, If the FLOW value is 50%, then the VALV value will also go to 50%; but at a dosage setting of 200%, the VALV value will go to 100%, or at a dosage setting of 75% the VALV value will go to 37.5%. If you feel that the values should be matching, but they are not, check your dosage settings.

7.2.3.3.1 NOTE: IF YOU HAVE PREVIOUSLY USED THE AUTOVALVE IN RESIDUAL OR COMPOUND LOOP CONTROL MODES, OR YOU ENTER THESE CONTROL MODES AND THEN SWITCH BACK TO FLOW PROPORTIONING MODE, IT IS VERY LIKELY THAT THE DOSAGE SETTING WILL HAVE CHANGED. THIS IS BECAUSE THE OTHER CONTROL MODES MAKE ADJUSTMENTS BY AUTOMATICALLY VARYING THE DOSAGE SETTING. HOWEVER, THE DOSAGE SETTING IN ANY OF THE CONTROL MODES IS CARRIED INTO ALL OF THE OTHER CONTROL MODES.

7.3 STOP

7.3.1 To exit the automatic valve control mode from the FLOW menu [38F] press the STOP key (F4).

7.3.2 This will take you back to the main "FLOW CONTROL" menu [1F].

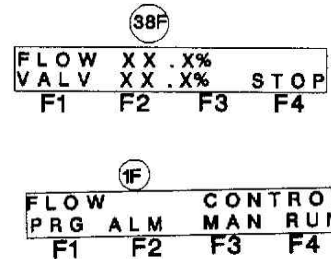

8.0 RESIDUAL CONTROL (Chlorination and De-Chlorination)

Follow procedures in this section after you have set the Control Mode to RES. See Section 5.2 SET CONTROL MODE, if your Opening Main Menu [1] does not indicate RESIDUAL CONTROL [1R]. It is important that you read instructions related to PASSWORDS, CALIBRATION, and ALARM SET POINTS, see Section 5.0, PROCEDURES COMMON TO ALL CONTROL MODES, before proceeding.

(1R)			
RESIDUAL	CONTROL		
PRG	ALM	MAN	RUN
F1	F2	F3	F4

8.1 CALIBRATE

8.1.1 If you have not previously calibrated the VALVE function, go to Section 5.3.1. It is not usually necessary to calibrate the input signal, but VALVE LINEARITY & SPAN Calibration should always be performed at initial start-up, whenever the motorized valve is disassembled, and after any occurrence which requires powering off and restarting the AutoValve in FACTORY DEFAULT mode (Hold F4 key while turning on power until "FACTORY DEFAULT" shows on screen, release F4 key).

8.2 PROGRAM

You must make certain settings in the PROGRAMMING section, which tell the AutoValve about your specific installation. The factory default settings cannot be used as an indicator of "ideal" settings, although in some instances they may happen to be the correct settings for your installation. The PROGRAMMING section for Residual Control mode is also used for Compound Loop Control Mode with the addition of a VARIABLE LAG setting.

8.2.1 From the main "RESIDUAL CONTROL" menu [1R] press the PRG key (F1).

(1R)			
RESIDUAL	CONTROL		
PRG	ALM	MAN	RUN
F1	F2	F3	F4

8.2.2 The "PASSWORD" menu [2] opens. Enter the password (Section 5.1.3 PASSWORD ENTRY SCREENS, for instructions).

(2)			
PASSWORD	0	*	*
UP↑	DWN↓	ESC	NXT
F1	F2	F3	F4

8.2.3 After entering the last password digit, and pressing the F4 key the "PROGRAMMING" menu [3] opens. Press the PRM key (F1).

(3)			
PROGRAMMING			
PRM	CAL	MODE	ESC
F1	F2	F3	F4

8.2.4 This will enter you into a series of settings menus (See the Menu Flow Diagrams in the Appendix), through which you will scroll by using UP (F1) and DWN (F2) keys. Within each of these menus you can choose to enter a Sub-Menu in order to make changes to the setting, set the value, and then return to the individual setting menu. When you leave the Settings section, the program remembers the last settings menu from which you exited, and will return to that menu the next time you enter the settings section. Each of the Settings menus is discussed below, in the order in which they appear. However, the first menu shown may not be the first menu which appears on the screen, but they will cycle back again so you will always return to the first which appeared. Pressing the ESC (F4) key on any Setting Menu will exit back to the "PROGRAMMING" menu [3].

8.2.4.1 RES FS [20]

8.2.4.1.1 The "RES FS" menu [20] refers to RESIDUAL FULL SCALE. You are required to set the maximum chlorine residual level which your analyzer will indicate at 20 mA output. The residual level is shown as Parts Per Million (PPM). This number is also indicative of Milligrams per Liter (mg/L). To change the setting press ADJ (F3).

(20)			
RES FS	20.00		
UP↑	DWN↓	ADJ	ESC
F1	F2	F3	F4

8.2.4.1.2 The "RES FS" Adjustment Sub-Menu [20A] opens. The sub menus are similar to the settings menu, but instead of the ESC (F4) key, they have a SET (F4) key, and do not have an ADJ (F3) key. Use the UP (F1) or DWN (F2) keys to change the setting. When the setting is correct, press the SET (F4) key, which will return you to the "RES FS" Setting menu [20].

(20A)			
RES FS	20.00		
UP↑	DWN↓	SET	
F1	F2	F3	F4

8.2.4.2 RES DP [21]

8.2.4.2.1 The “RES DP” menu [21] allows you to change the number of decimal points used in setting the chlorine residual. This number can be set from ZERO decimal points, up to 3 decimal points. NOTE: CHANGING THE NUMBER OF DECIMAL POINTS AFFECTS ALL RESIDUAL SETPOINTS AND READOUTS. IF YOU CHANGE THE NUMBER OF DECIMAL POINTS YOU MUST ALSO ADJUST THE RESIDUAL SETPOINT, RESIDUAL FULL SCALE SETTING, AND To change this setting press ADJ (F3).

(21)

RES DP	X . XXX		
UP ↑	DWN ↓	ADJ	ESC
F1	F2	F3	F4

8.2.4.2.2 The “RES DP” Adjustment Sub-Menu [21A] opens. The sub menus are similar to the settings menu, but instead of the ESC (F4) key, they have a SET (F4) key, and do not have an ADJ (F3) key. Use the UP (F1) or DWN (F2) keys to change the setting. When the setting is correct, press the SET (F4) key, which will return you to the “RES DP” Setting menu [21].

(21A)

RES DP	X . XXX	
UP ↑	DWN ↓	SET
F1	F2	F4

8.2.4.3 GAS TYPE [22]

8.2.4.3.1 The “GAS TYPE” menu [22] allows you to choose whether you are feeding Chlorine or Sulfur Dioxide gas. When you choose Sulfur Dioxide (SO₂) the AutoValve will automatically be in DE-CHLORINATION control mode. To change this setting press ADJ (F3).

(22)

GAS TYPE	CL 2		
UP ↑	DWN ↓	ADJ	ESC
F1	F2	F3	F4

8.2.4.3.2 The “GAS TYPE” Adjustment Sub-Menu [22A] opens. The sub menus are similar to the settings menu, but instead of the ESC (F4) key, they have a SET (F4) key, and do not have an ADJ (F3) key. Use the UP (F1) or DWN (F2) keys to change the setting. When the setting is correct, press the SET (F4) key, which will return you to the “GAS TYPE” Setting menu [22].

(22A)

GAS TYPE	CL 2	
UP ↑	DWN ↓	SET
F1	F2	F4

8.2.4.4 P(GAIN) [23]

8.2.4.4.1 The “P(GAIN)” menu [23] allows you to choose the sensitivity of the controller to residual changes. If you are unfamiliar with this concept, you should read Section 2.3.3 P(GAIN), which contains a more detailed explanation. The factory default setting of 100% is usually a good starting point from which to observe the control system’s response to residual variations, and to then make adjustments if needed. Lowering this value will reduce the sensitivity, while increasing the value will make the controller react more quickly, though in bigger steps. The P(GAIN) can be set anywhere within a range of 0% to 1000%. If residual Levels rise too much before the control system can begin to bring them back to the set point, then you should increase the P(GAIN) setting. If the residual levels are fluctuating up and down around the set point, then you should decrease the P(GAIN) setting. To change this setting press ADJ (F3).

(23)

P (GAIN)	100%		
UP ↑	DWN ↓	ADJ	ESC
F1	F2	F3	F4

8.2.4.4.2 The “P(GAIN)” Adjustment Sub-Menu [23A] opens. The sub menus are similar to the settings menu, but instead of the ESC (F4) key, they have a SET (F4) key, and do not have an ADJ (F3) key. Use the UP (F1) or DWN (F2) keys to change the setting. When the setting is correct, press the SET (F4) key, which will return you to the “P(GAIN)” Setting menu [23].

(23A)

P (GAIN)	100%	
UP ↑	DWN ↓	SET
F1	F2	F4

8.2.4.5 LAGFIX [24]

8.2.4.5.1 The “LAGFIX” menu [24] allows you to set the time, in seconds, that it takes for the chlorine or sulfur dioxide gas injected into

(24)

LAGFIX	1 S		
UP ↑	DWN ↓	ADJ	ESC
F1	F2	F3	F4

the water, to reach the analyzer, go through the measuring cell, and send the resulting reading back to the AutoValve controller. This value must be calculated based upon the water flow rate in the system, added to the analyzer sampling time. Standard tables are available to determine the speed of travel of water in pipe of various diameters with a known water flow rate in gallons per minute, liters per second, etc. The controller will wait this amount of time before making its next adjustment. This setting is very important for obtaining the maximum control performance of the AutoValve. To change this setting press ADJ (F3).

- 8.2.4.5.1 The “LAGFIX” Adjustment Sub-Menu [24A] opens. The sub menus are similar to the settings menu, but instead of the ESC (F4) key, they have a SET (F4) key, and do not have an ADJ (F3) key. Use the UP (F1) or DWN (F2) keys to change the setting. When the setting is correct, press the SET (F4) key, which will return you to the “LAGFIX” Setting menu [24].

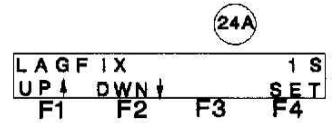

8.2.4.6 **DEADBAND [DB]**

- 8.2.4.6.1 The “DEADBAND” menu [DB] allows you to set the amount of set point deviation, in PPM, which must exist before the controller will react and start taking corrective action. If this value is set at zero (0), the valve will react to minute variations in the residual input signal and may result in constant “hunting” around the set point. Usually, a setting of 0.01 or 0.02 PPM will give very satisfactory results. If you experience too much valve movement around the set point, then you can set the DEADBAND at a higher number until you are satisfied with the reaction sensitivity. To change the setting, press ADJ (F3).

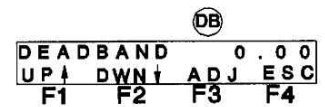

- 8.2.4.6.2 The “DEADBAND” Adjustment Sub-Menu [DB1] opens. The sub menus are similar to the settings menu, but instead of the ESC (F4) key, they have a SET (F4) key, and do not have an ADJ (F3) key. Use the UP (F1) or DWN (F2) keys to change the setting. When the setting is correct, press the SET (F4) key, which will return you to the “DEADBAND” Setting menu [DB].

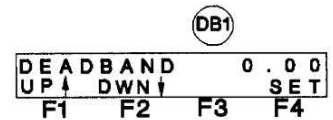

- 8.2.5 After all PROGRAM Settings have been completed, press the ESC key (F4) on any Settings Menu. This will exit the settings section and return to the “PROGRAMMING” Menu [3]. Press ESC (F4).

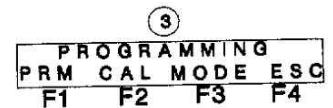

- 8.2.5 Exit through the “SET NEW PASSWORD” Menus (See Section 5.1.5) to the main “RESIDUAL CONTROL” menu [1R].

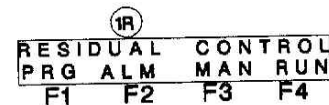

8.3 **RUN**

- 8.3.1 From the “RESIDUAL CONTROL menu [1R], press the RUN key (F4).

- 8.3.2 The “RES SP” menu [35R] (Residual Set Point) opens. This menu allows you to choose whether to change the current Residual set point, or go directly to the automatic Residual Control operation “FLOW” Menu [38R], described below.

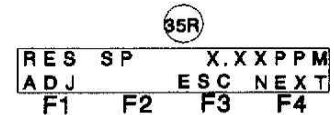

- 8.3.2.1 To change the current Residual Setpoint, press the ADJ key (F1).

- 8.3.2.1.1 The “PASSWORD” menu [36R] opens. Enter the password (Section 5.1.3 PASSWORD ENTRY SCREENS, for instructions).

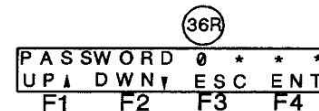

- 8.3.2.1.2 After entering the last password digit, and pressing the F4 key the “RES SP” menu [37R] opens.

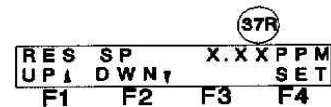

8.3.2.1.3 Use the UP (F1) or DWN (F2) keys to adjust the Residual set point. The setting can be any number between 0 and the Residual Full Scale setting (RES FS).

8.3.2.1.4 When the Residual set point value is correct, press the SET key (F4). This will open the RES menu [38R].

8.3.3 At the RES menu [38R] the valve will be in automatic operation.

8.3.3.1 The Input signal from the Residual analyzer will be shown next to RES as Parts per Million (PPM). The Residual Set Point will be shown next to SP as Parts per Million (PPM). When there is a difference between these two values, the AutoValve will move up or down to change the gas feed rate.

8.3.3.2 The valve position will be shown next to VALV as a percentage of the maximum calibrated valve opening.

38R			
RES	X.XX	SP	X.XX
FLOW	XX.X%	STOP	
F1	F2	F3	F4

8.4 STOP

8.4.1 To exit the automatic valve control mode from the RES menu [38R] press the STOP key (F4).

8.4.2 This will take you back to the main "RESIDUAL CONTROL" menu [1R].

1R			
RESIDUAL	CONTROL		
PRG	ALM	MAN	RUN
F1	F2	F3	F4

9.0 COMPOUND LOOP CONTROL (Chlorination and De-Chlorination)

Compound Loop Control differs only slightly from RESIDUAL CONTROL, in terms of the operator interface. The “behind the scenes” algorithms and other programming (firmware) will not be apparent. Therefore, this section will only deal with the few added procedures that must be performed, which are not covered in the RESIDUAL CONTROL Section 8.0. Everything covered in SECTION 8.0, RESIDUAL CONTROL applies to COMPOUND LOOP CONTROL as well.

Follow procedures in this section after you have set the Control Mode to COMP. See Section 5.2 SET CONTROL MODE, if your Opening Main Menu [1] does not indicate COMPOUND CONTROL [1C]. It is important that you read instructions related to PASSWORDS, CALIBRATION, and ALARM SET POINTS, see Section 5.0, PROCEDURES COMMON TO ALL CONTROL MODES, before proceeding.

①C

COMPOUND CONTROL			
PRG	ALM	MAN	RUN
F1	F2	F3	F4

9.1 PROGRAM

All of the program variables discussed above for Residual Control, including the discussion regarding De-Chlorination with SO₂ gas, also apply for Compound Loop Control, with the addition of the “LAG” type setting. This allows the **LAG TIME** value which was set for a particular water flow rate, to be automatically varied as the water flow rate increases or decreases. By allowing **VARIABLE LAG TIME** the analyzer always “sees” the sample after equal mixing has taken place. For example; if water flow in a pipeline doubles (a second well pump comes on line) the amount of time it takes for the treated water to reach the analyzer is one-half the previous amount, and the **VARIABLE** setting will automatically adjust the **LAG TIME**. However, in many “open” treatment systems, higher water flow rates do not necessarily increase the speed at which water travels through the system (at least not proportionately) and the **FIXED** setting may be chosen.

9.1.1 Follow Section 8.2.4 of RESIDUAL CONTROL, from the PROGRAMMING Menu [3]. After pressing PRM key (F1) and making any adjustments to the settings shown in RESIDUAL CONTROL, you will encounter the “LAG” menu [25]. You may choose to only allow a FIXED LAG TIME, or a VARIABLE LAG TIME as mentioned above. To change the method of setting LAG TIME, press the ADJ key (F3).

②5

LAG	VARIABLE		
UP↑	DWN↓	ADJ	ESC
F1	F2	F3	F4

9.1.1.1 The “LAG” Adjustment Sub-Menu [25A] opens. The sub menus are similar to the settings menu, but instead of the ESC (F4) key, they have a SET (F4) key, and do not have an ADJ (F3) key. Use the UP (F1) or DWN (F2) keys to change the setting between VARIABLE and FIXED. When the setting is correct, press the SET (F4) key, which will return you to the “LAG” Setting menu [25].

②5A

LAG	VARIABLE		
UP↑	DWN↓	SET	
F1	F2	F3	F4

9.1.2 If you choose to have a FIXED LAG TIME, then the LAG menu [25] will appear as LAG FIXED and no other settings need to be made.

②5

LAG	FIXED		
UP↑	DWN↓	ADJ	ESC
F1	F2	F3	F4

9.1.3 If you choose to have a VARIABLE LAG TIME, then the LAG menu [25] will appear as LAG VARIABLE, and **two (2) additional menus** will now be added to the settings menu list. When making your settings for the VARIABLE LAG TIME, you must know what the lag time is at a particular water flow rate. For Example, if you choose to set lag variable based on 50% of maximum water flow, you must know (or calculate) the lag time, in seconds, at that flow rate. These two values will be used in the following settings:

②5

LAG	VARIABLE		
UP↑	DWN↓	ADJ	ESC
F1	F2	F3	F4

9.1.3.1 LAG VAR [VAR1]

9.3.1.1.1 The “LAG VAR” menu [VAR1] allows you to choose the lag time you will use to set the Variable Lag. To change this setting press ADJ (F3).

②VAR1

LAG VAR	10S	
UP↑	DWN↓	ESC
F1	F2	F4

9.3.1.1.2 The “LAGVAR” Adjustment Sub-Menu [VAR1A] opens. The sub menus are similar to the settings menu, but instead of the ESC (F4) key, they have a SET (F4) key, and do not have an ADJ (F3) key. Use the UP (F1) or DWN (F2) keys to change

②VAR1A

LAG VAR	10S	
UP↑	DWN↓	SET
F1	F2	F4

the Lag Time, in seconds, at the water flow you choose to use for this setting.. When the setting is correct, press the SET (F4) key, which will return you to the “LAG VAR” Setting menu [VAR1].

9.1.3.2 **FLOW@VAR** [VAR2]

9.1.3.2.1 The “FLOW@VAR” menu [VAR2] allows you to choose the water flow, in percentage of maximum, which corresponds to the LAG VAR [VAR1]time which you set above.

9.1.3.2.1 The “FLOW@VAR” Adjustment Sub-Menu [VAR2A] opens. The sub menus are similar to the settings menu, but instead of the ESC (F4) key, they have a SET (F4) key, and do not have an ADJ (F3) key. Use the UP (F1) or DWN (F2) keys to change the Water Flow Rate, in percentage of maximum, at the Lag Time you chose to use for this setting.. When the setting is correct, press the SET (F4) key, which will return you to the “FLOW@VAR” Setting menu [VAR2]

9.1.4 After all PROGRAM Settings have been completed, press the ESC key (F4) on any Settings Menu. This will exit the settings section and return to the “PROGRAMMING” Menu [3]. Press ESC (F4).

9.1.5 Exit through the “SET NEW PASSWORD” Menus (See Section 5.1.5) to the main “COMPOUND CONTROL” menu [1C].

9.2 RUN

All RUN functions are the same in COMPOUND LOOP mode as in RESIDUAL CONTROL MODE. Follow the procedures in Section 8.3. The only difference you will note is when you enter the RES menu [38C], you will see a FLOW indication , which shows the percentage of maximum gas feed rate, as the flow meter input signal varies.

9.3 STOP

9.3.1 To exit the automatic valve control mode from the RES menu [38C] press the STOP key (F4).

9.3.2 This will take you back to the main “COMPOUND CONTROL” menu [1C].

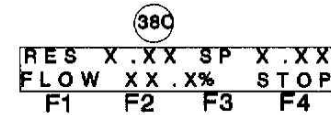
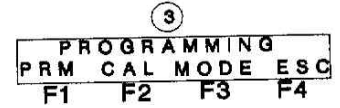
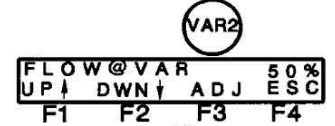
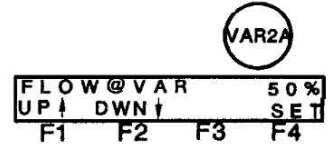
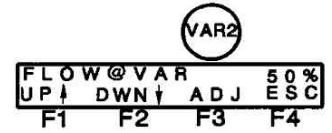

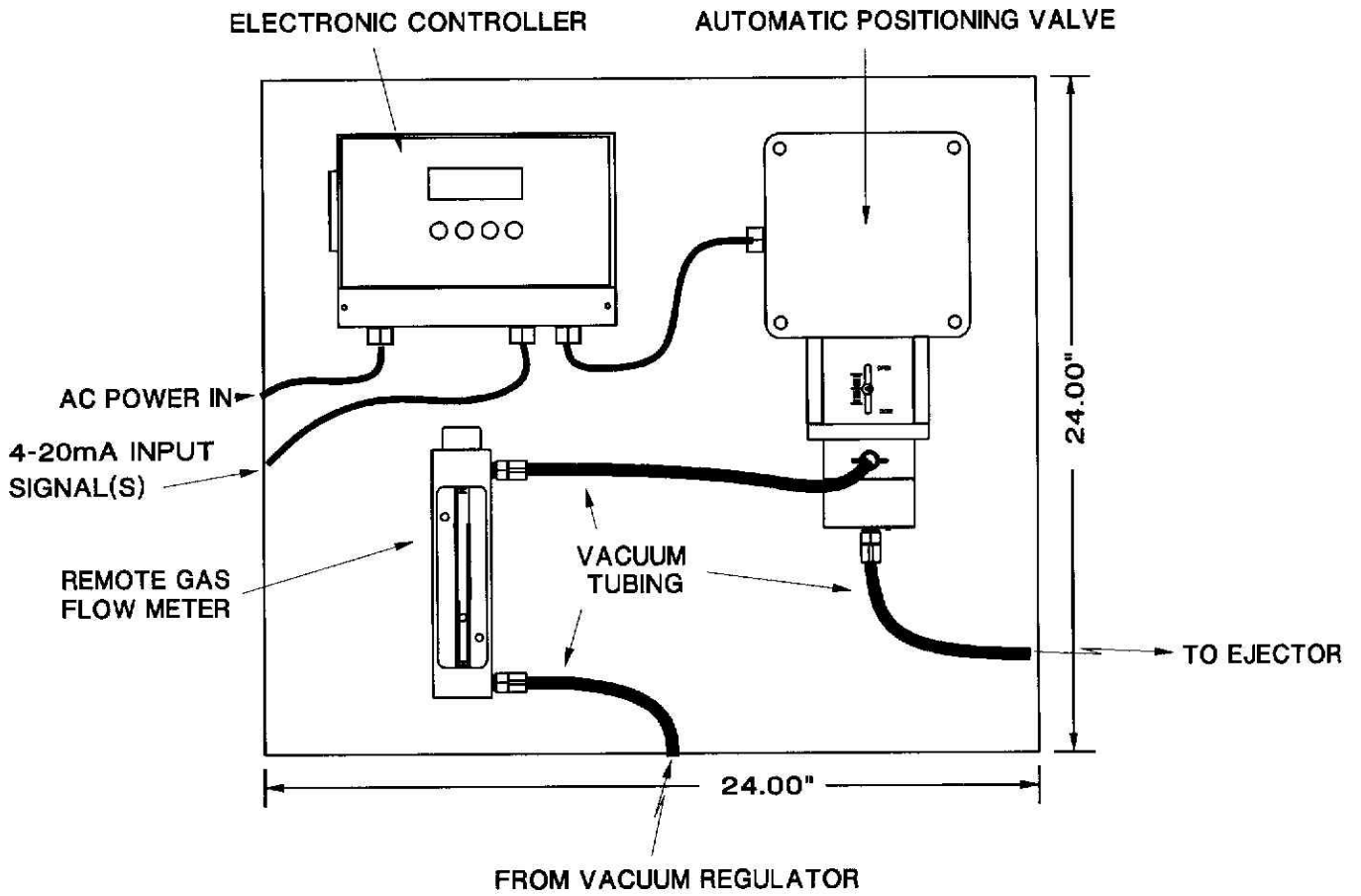

FIGURE 3.1

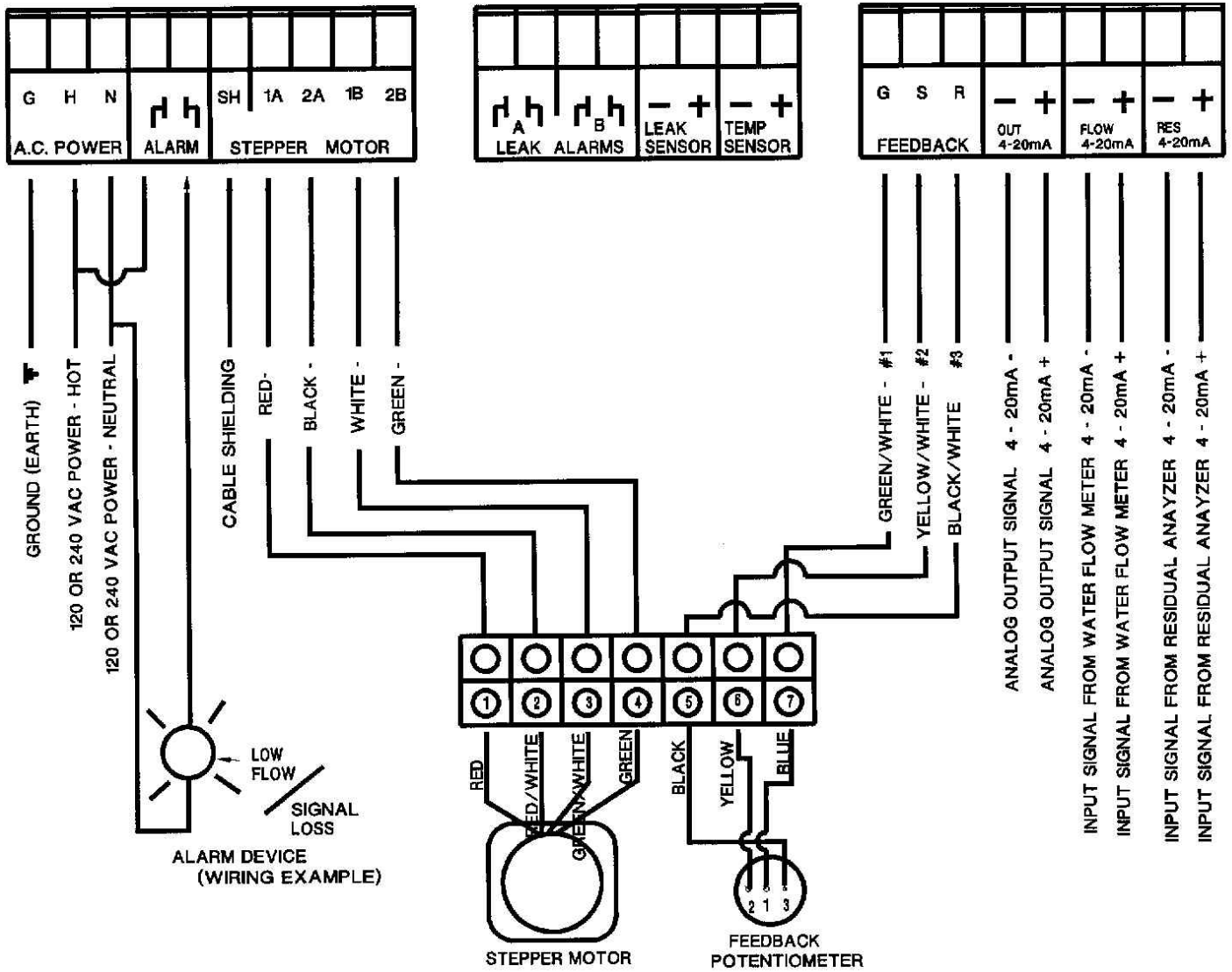
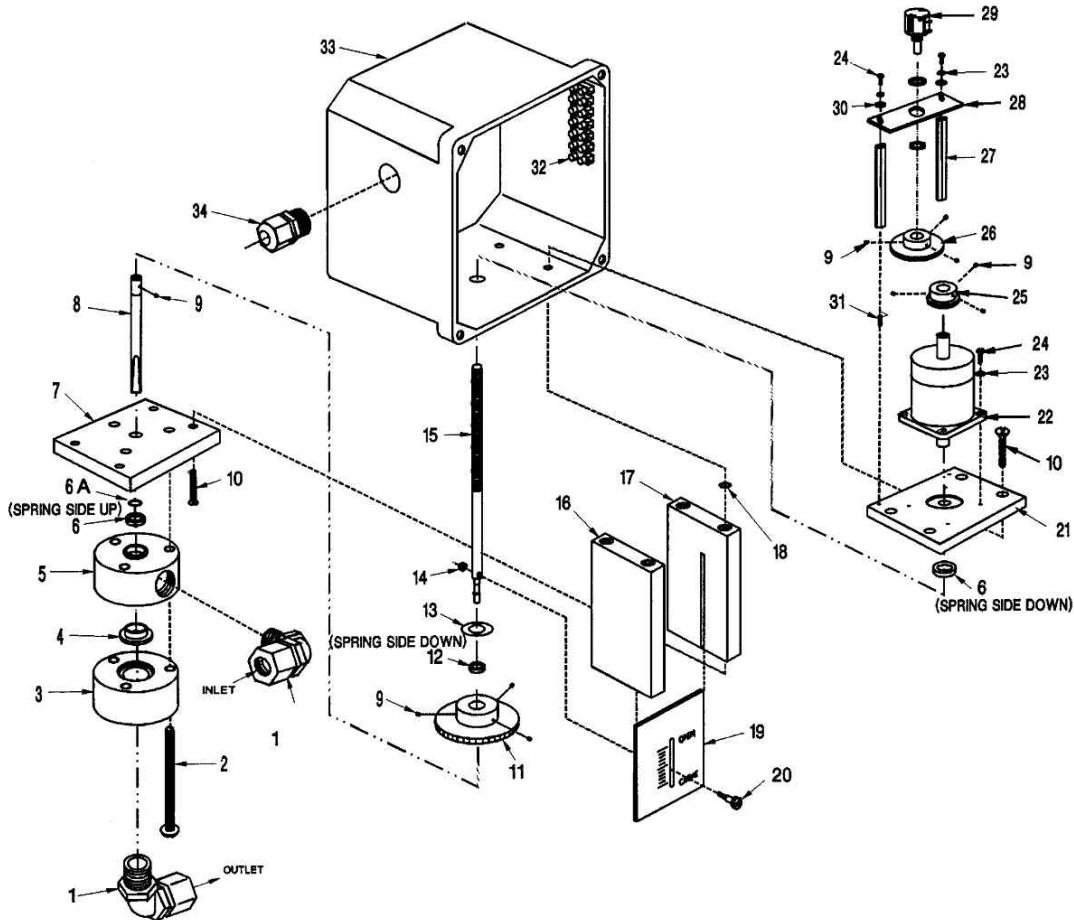



FIGURE 3.2



KEY	QTY	DESCRIPTION	PART NO
1	2	1/4" TUBE X 1/2" NPT ELL TO 100PPD (2 KG/HR)	TU-157
	2	1/2" TUBE X 1/2" NPT ELL TO 200 PPD (5 KG/HR)	TU-256
	2	5/8" TUBE X 1/2" NPT ELL TO 500 PPD (10 KG/HR)	TU-556
2	3	1/4-20 UNC X 3 1/2" SS RND HEAD MACH SCREW	AV-105
3	1	VALVE COVER	AV-001
4	1	VALVE ORIFICE	AV-003
5	1	VALVE BODY	AV-002
6	2	SPRING-ACTIVATED PTFE SEAL (3/8" I.D.)	AV-030
6A	1	VALVE BODY O-RING SEAL	OR-115
7	1	VALVE BODY MOUNTING PLATE	AV-014
8	1	VALVE PLUG ASSEMBLY TO 10PPD(200 GR/HR)	AV-200-10
	1	VALVE PLUG ASSEMBLY TO 25PPD(500 GR/HR)	AV-200-25
	1	VALVE PLUG ASSEMBLY TO 50PPD(1000 GR/HR)	AV-200-50
	1	VALVE PLUG ASSEMBLY TO 100PPD (2 KG/HR)	AV-200-100
	1	VALVE PLUG ASSEMBLY TO 200PPD (5 KG/HR)	AV-200-200
	1	VALVE PLUG ASSEMBLY TO 500PPD (10 KG/HR)	AV-200-500
9	10	4-40 UNC X 3/16" SS SET SCREW	AV-104
10	8	10-24 UNC X 1 1/4" SS FLAT HD MACH SCREW	AV-101
11	1	HAND WHEEL	AV-008
12	1	SPRING-ACTIVATED PTFE SEAT (1/4" ID)	AV-031
13	1	PTFE FRICTION WASHER	SP-160
14	1	6-32 UNC SS HEX NUT	AV-120
15	1	LEAD SCREW	AV-007
16	1	VALVE SUPPORT PLATE, RIGHT SIDE	AV-016
17	1	VALVE SUPPORT PLATE, LEFT SIDE	AV-017
18	4	SEAL, SUPPORT PLATE TO HOUSING BOX	OR-114
19	1	GUIDE PLATE	AV-009
20	1	INDICATOR SHOULDER SCREW (6-32 UNC)	AV-010
21	1	MOTOR MOUNTING PLATE	AV-015
22	1	LINEAR ACTUATOR MOTOR	AV-100
23	6	SS LOCK WASHER	AV-130

KEY	QTY	DESCRIPTION	PART NO
24	6	SS PAN HEAD MACHINE SCREW	AV-102
25	1	FEEDBACK PINION GEAR	AV-012
26	1	FEEDBACK SPUR GEAR	AV-013
27	2	HEX STANDOFF	AV-060
28	1	FEEDBACK POTENTIOMETER MNTNG PLATE	AV-011
29	1	FEEDBACK POTENTIOMETER	AV-050
30	2	SS FLAT WASHER	AV-131
31	2	SS SET SCREW	AV-103
32	1	TERMINAL STRIP (7-POSITION)	AV-045
33	1	MOTOR HOUSING BOX	AV-040
34	1	1/2" STRAIN RELIEF LIQUID-TIGHT CONNECTOR	STC-EL-112

	CHEMICAL INJECTION TECHNOLOGIES
SUPERIOR AUTOVALVE VALVE ACTUATOR ASSEMBLY	
BY: CDT	DATE: 7 SEPT '01
SCALE: NTS	DWG NO: AVVL-1/2/5

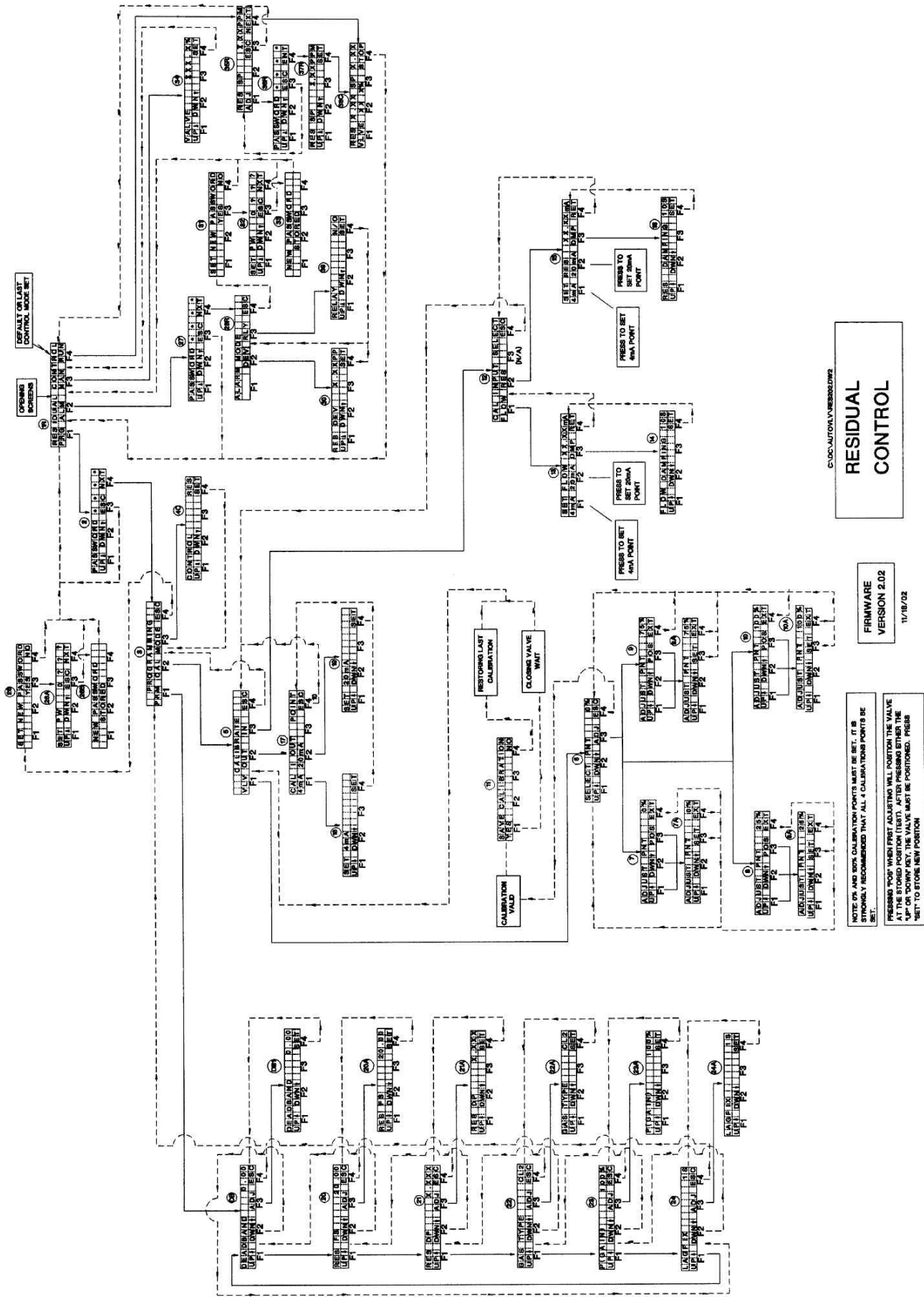

RESIDUAL CONTROL

FIRMWARE VERSION 2.02
11/18/02

NOTE: 0% AND 100% CALIBRATION POINTS MUST BE SET. IT IS STRONGLY RECOMMENDED THAT ALL 4 CALIBRATION POINTS BE SET.
PRESSING "0%" WHEN FIRST ADJUSTING WILL POSITION THE VALVE AT THE STORED POSITION (IF SET). AFTER PRESSING EITHER THE "UP" OR "DOWN" KEY, THE VALVE MUST BE POSITIONED. PRESS "SET" TO STORE NEW POSITION.

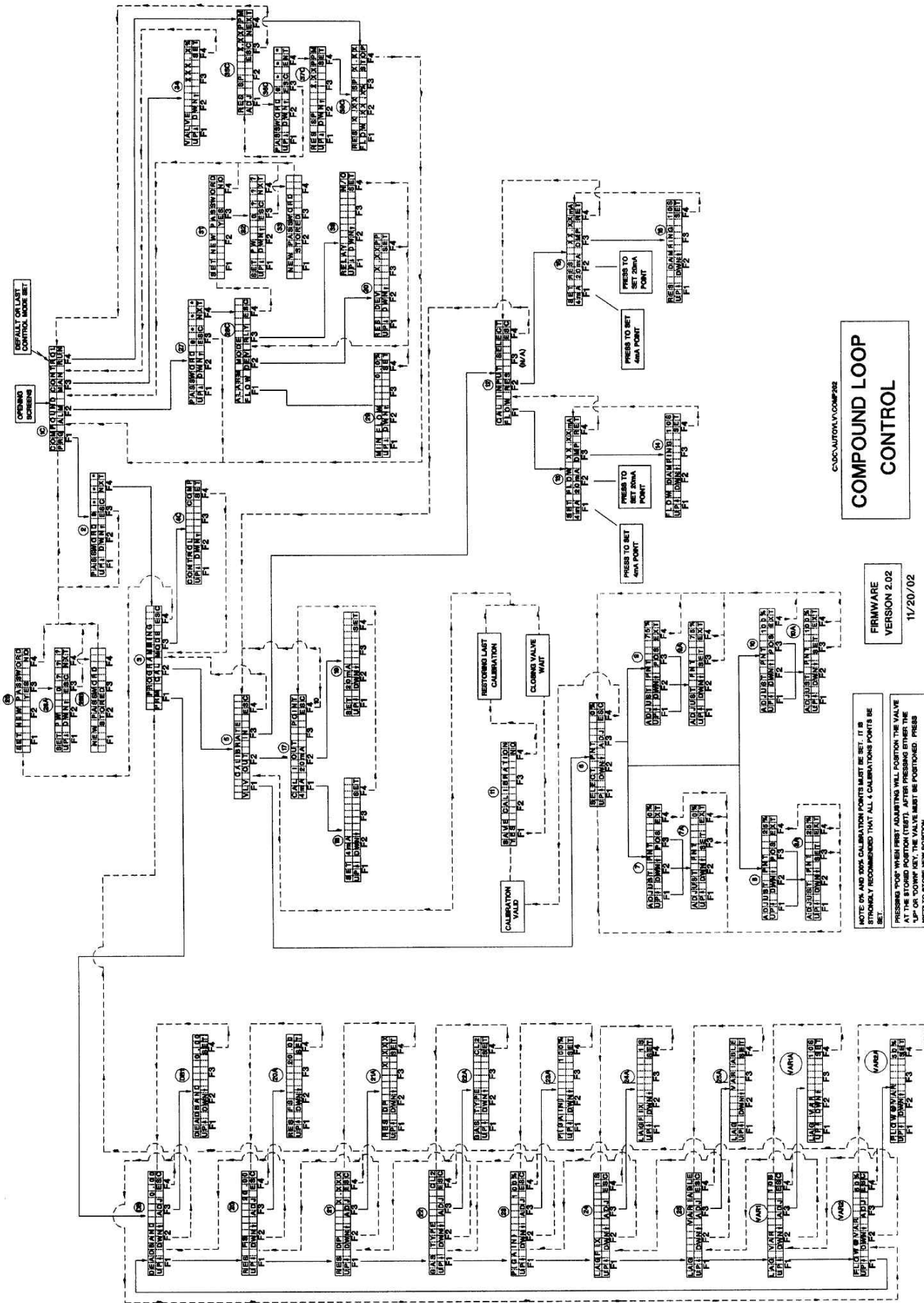

CUCO-AUTONVA-COMP202

COMPOUND LOOP CONTROL

FIRMWARE VERSION 2.02
11/20/02

NOTE ON AND 100% CALIBRATION POINTS MUST BE SET. IT IS HIGHLY RECOMMENDED THAT ALL 4 CALIBRATION POINTS BE SET.
PRESSING "POP" WHEN FIRST ADJUSTING WILL POSITION THE VALVE AT THE STORING POSITION. AFTER THE ADJUSTMENT IS MADE AT THE STORING POSITION THE VALVE MUST BE POSITIONED. PRESS "SET" TO STORE NEW POSITION.